

Model:
TFP-72-30M-D-4-HC

Food Prep Table:
Food Prep Unit with Drawers & Hydrocarbon Refrigerant

TFP-72-30M-D-4-HC

- ▶ True's food prep units are designed with enduring quality that protects your long term investment.
- ▶ Energy saving, environmentally friendly, exclusive forced-air refrigeration system holds 0.5°C to 5°C.
- ▶ Exterior - stainless steel front, top and ends. GalFan coated steel back.
- ▶ Stainless steel, patented lid and hood. Removable for easy cleaning.
- ▶ Interior - attractive, NSF approved, clear coated aluminum liner. Stainless steel floor with coved corners.
- ▶ 204 mm deep, 13 mm thick, full length removable cutting board included.
- ▶ Sanitary, NSF approved white polyethylene provides tough preparation surface.
- ▶ Each drawer accommodates one (1) 1/1GN (W 530mm x D 325 x H 150mm) + three (3) 1/9 GN food pans (sold separately).
- ▶ Foamed-in-place using a high density, environmentally friendly polyurethane insulation.



NOTE: Door or drawer assemblies can be located in any section of the cabinet. Location of doors/drawers must be indicated at time of ordering.

PLAN VIEW

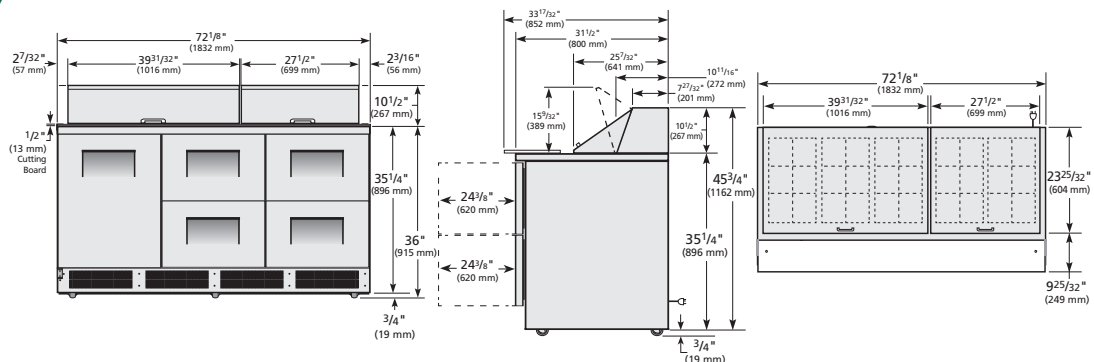

ROUGH-IN DATA

Voltage: 220-240V/50Hz

Specifications subject to change without notice.
Chart dimensions rounded up to the next whole millimeter (inches rounded up to the next 1/8").

Model	Doors/Drawers	Shelves	Cabinet Dimensions (mm)			HP	Amps	Pans (top)	Refrigerant	Crated Weight (kg)
			W	D†	H*					
TFP-72-30M-D-4-HC	1/4	2	1832	801	1181	1/4	2,5	30	R290	291

† Depth does not include 51 mm for cutting board.

* Height for all units are with the lid(s) closed.